

# Prizm Urinal Wall Supply



**Model 8946-W**  
Prizm Urinal  
Wall Supply,  
Off-Floor, Wall Waste

All urinals specified on this sheet are configured with a 1-1/2" NPT back spud inlet for a wall supply (concealed) flush valve (flush valve sold separately).

- **Angular Commercial WASHOUT Urinal Requiring Commercial Water Supply Line to Operate. Water Flow Pressure 35 psi (2.41 bars); Water Supply Line 1" (25 mm).**
- **WALL SUPPLY (Exposed) Flush Valve Configuration**  
Compatible Flush Valve (Sold Separately) Releases 1.0 Gallons (3.8 Liters) per Flush. Top Supply Flush Valve configurations are also available.
- **16-Gage STAINLESS STEEL CONSTRUCTION**  
Satin Finish is Standard;  
Also Available in Mira Finish (High Polish)
- **ADA Compliant**  
Urinals are Compliant when Properly Installed 
- **ANSI, UFAS Compliant**

DESCRIPTION	MODEL/OPTION #
<b>CONFIGURATION</b> - Required Selection	INIT.

**WALL SUPPLY COMMERCIAL PRIZM URINAL**

**Off-Floor, Wall Waste Configuration**

- ( **Satin Finish** (Standard) 8946-W
- ( **Mira Finish** (High Polish) 8946-W-HP



**ADA COMPLIANT**

Properly mounted 8946-W urinals are ADA Compliant. ADA compliance is subject to the interpretation and requirements of local code authority. Please check your local ADA regulations

Add(+)

FLUSH VALVE SELECTION	INIT.
-----------------------	-------

**Wall Supply (Concealed) Flush Valves**

Requires commercial water supply to operate; Water flow pressure 35 psi (2.41 bars); Water supply line is 1" (25 mm) diameter; Flush valve releases 1.0 gallons (3.8 liters) per flush; flush valve sold separately from fixture.



( **Manual Flush** FV1.0-W



( **Hydraulic** FV1.0-W-H   
ADA Compliant

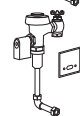

( **Electronic Sensor** FV1.0-W-SO   
Valve requires 120 VAC, 60Hz  
Plug-in Power Supply

**CONSTRUCTION AND PLUMBING INFORMATION**

**Must Specify: Wall Thickness** \_\_\_\_\_

**Must Specify: Wall Type** \_\_\_\_\_  
(Eg. drywall with tile, concrete, etc)



Flush Valve Accessories on the next page







**Prizm Urinal Wall Supply**



**Model 8946-W**  
Prizm Urinal  
Wall Supply,  
Off-Floor, Wall Waste

**Orders will not be processed until specification sheets are complete and signed. NO CANCELLATIONS.**

	DESCRIPTION	MODEL/OPTION #	
<b>Add (+)</b>	<b>FLUSH VALVE ACCESSORIES</b>		
		<small>INIT.</small>	
		<b>14" x 14" Flush Valve Access Panel</b> ( <b>Satin</b> with Push Button Hole )	4080-000-001
		( <b>Mira (High Polish)</b> with Push Button Hole )	4080-030-001
		( <b>Satin</b> No Hole )	4080-035-001
		( <b>Mira (High Polish)</b> No Hole )	4080-036-001
	<b>10" x 10" Flush Valve Access Door</b> ( <b>Satin</b> )	0530-135-001	
	( <b>Mira (High Polish)</b> )	0530-118-001	
	<b>12" x 12" Tile-In Flush Valve Access Door</b> ( <b>Satin</b> )	0530-140-001	

 **APPROVAL FOR MANUFACTURE**

COMPANY: \_\_\_\_\_

PROJECT NAME: \_\_\_\_\_

SIGNEE'S NAME WRITTEN CLEARLY: \_\_\_\_\_

DATE \_\_\_\_\_

AUTHORIZED SIGNATURE: \_\_\_\_\_



**WARNING:** Cancer and Reproductive Harm - [www.P65Warnings.ca.gov](http://www.P65Warnings.ca.gov)

**NEO-METRO**  
15125 Proctor Ave. • City of Industry, CA 91746 USA  
TF 800.591.9050 • PH 626.855.4854 • FX 626.937.4725  
Neo-Metro is a Member of Morris Group International

# Prizm Urinal Wall Supply

**PRODUCT Specification . . .** Prizm Urinal is an angular washout type urinal. Fixture is fabricated from 16-gage, Type 304 stainless steel. Satin Finish Stainless Steel is standard. The toilet is also available in Mira (high polish) Stainless Steel. Supplied with a 1-1/2" (38 mm) P-trap for waste outlet. Model 8946-W is configured for a Wall Supply flush valve (sold separately). Top Supply configurations are also available. Urinals shall be wall mounted with a recommended rim height of 20" (508 mm ) above finished floor. Urinals meet ASME/ANSI guidelines as outlined in A112.19.2.

**PLUMBING Specification . . .** Wall mounted washout urinal utilizing a commercial supply line (1" or 25 mm) water inlet into flush valve and 3/4" or 19 mm water inlet into fixture) and 2" (51 mm) in-wall waste line. The urinal is supplied with a 4" (101 mm) x 1-1/2" (38 mm) plain end waste connection. Check applicable plumbing codes. Model 8946-W is configured with a back spud inlet for a Wall Supply (concealed) flush valve. Flush valves are sold separately. Compatible flush valves release 1 gallon (3.8 liters) per flush.

 The urinal is ADA compliant if installed with a rim height of 17" (432 mm) and appropriate flush valve is used. Other ADA considerations may be required. Please check your local ADA regulations.

**8946-W  
WALL SUPPLY  
PRIZM URINAL**

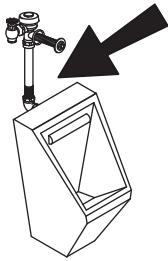

**WALL SUPPLY -**  
Back Spud Inlet for  
Wall Supply (Concealed)  
Commercial Flush Valve  
(valve sold separately)

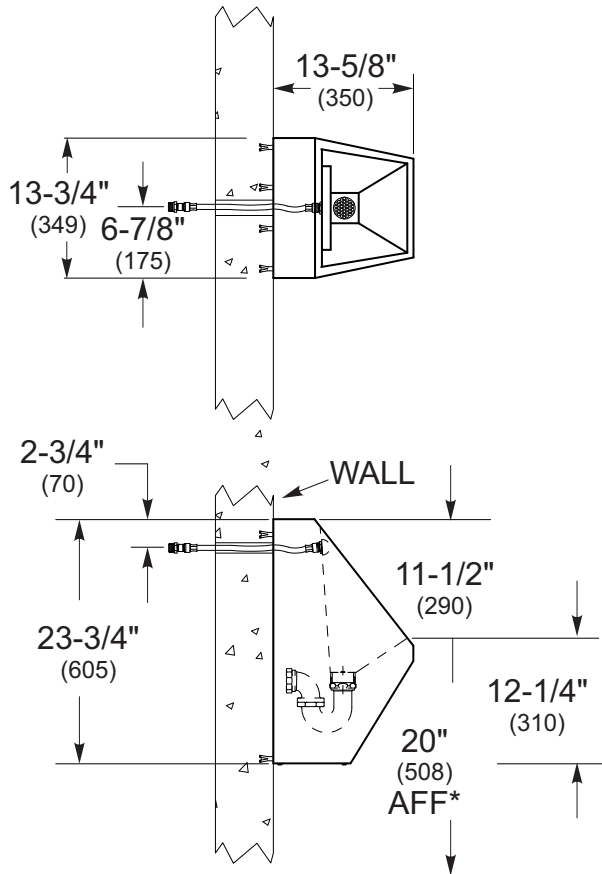

**\* ADA COMPLIANT**  
Properly mounted 8946-W urinals are ADA Compliant. The rim of the urinal is recommended no more than 17" (432 mm) above finished floor. An ADA compliant flush valve must also be used. ADA compliance is subject to the interpretation and requirements of local code authority. Please check your local ADA regulations.

Neo-Metro assumes no responsibility for use of void or suspended data. All dimensions are nominal and subject to manufacturer change without notice.

**INSTALLATION INSTRUCTIONS ARE AVAILABLE**