

Metropolis Basin



Model 8930

Model 8931-RLL

Model 8931-RLS

U.S. Design Patent 433743



Model Shown Above:

Model 8930 (D Shaped Bowl) shown with -H36 Faucet Configuration

Model 8931-RLL (Large Round Bowl) -H0 Faucet Configuration only

Model 8931-RLS (Small Round Bowl) shown with -H1 Faucet Configuration

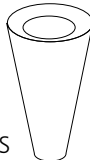
- **ONE PIECE CONICAL PEDESTAL WASH BASIN**
 - **Heavy 16-Gage Stainless Steel Construction**
 - **Three Finishes Available**
 - Satin Finish (entire unit)
 - Mira Finish Rim (Satin Finish Fixture/Mira Rim)
 - Mira High Polish Finish - All (entire unit)
 - **Three Bowl Options Available**
 - D Shaped Bowl
 - Large Round Bowl (15-3/4" Diameter)
 - Small Round Bowl (11-1/2" Diameter)
 - **Concealed Access Panel**
- NOTE: Faucet is Sold Separately**

DESCRIPTION	MODEL/OPTION #
METROPOLIS BASIN - D BOWL INIT.	
<input type="checkbox"/> Satin Finish Entire Fixture is in Satin Finish	8930-S
<input type="checkbox"/> Mira Finish Rim Satin Finish Fixture with Mira High Polish Rim	8930-HPR
<input type="checkbox"/> Mira Finish - All Entire Fixture is in Mira High Polish Finish	8930-HPA
FAUCET CONFIGURATION	
<input type="checkbox"/> Single Hole	- H1
Neo-Metro Deck Mounted Faucet is available for this Metropolis Basin (Sold Separately)	
<input type="checkbox"/> -NMF-2-S (Satin Finish)	<input type="checkbox"/> - NMF-2-HP (Mira High Polish)
<input type="checkbox"/> 6" (152 mm) Center Set	- H36
<input type="checkbox"/> Less Punching	- H0 (Requires Wall Mounted Faucet)
BOWL OVERFLOW OPTION	
<input type="checkbox"/> Overflow Outlet	- OF
METROPOLIS BASIN - LARGE ROUND BOWL INIT.	
15-3/4" (400 mm) Round Inner Bowl	
<input type="checkbox"/> Satin Finish Entire Fixture is in Satin Finish	8931-RLL-S
<input type="checkbox"/> Mira Finish Rim Satin Finish Fixture with Mira High Polish Rim	8931-RLL-HPR
<input type="checkbox"/> Mira Finish - All Entire Fixture is in Mira High Polish Finish	8931-RLL-HPA
FAUCET CONFIGURATION	
<input type="checkbox"/> Less Punching	- H0 (Requires Wall Mounted Faucet; This is the only option for this Metropolis Basin.)
BOWL OVERFLOW OPTION	
<input type="checkbox"/> Overflow Outlet	- OF
 <p>Model 8931-RLS</p>	
	



Neo-Metro is a Member of U.S. Green Building Council



Metropolis Basin



**Model
8931-RLS**

U.S. Design Patent 433743

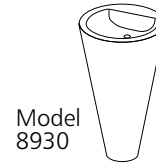

Model
8930

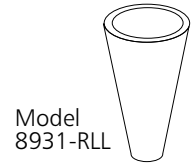

Model
8931-RLL

DESCRIPTION	MODEL/OPTION #
METROPOLIS BASIN - SMALL ROUND BOWL	INIT. _____

11-1/2" (292 mm) Round Inner Bowl

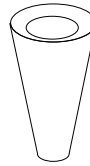

- Satin Finish** 8931-RLS-S
Entire Fixture is in Satin Finish
- Mira Finish Rim** 8931-RLS-HPR
Satin Finish Fixture with Mira High Polish Rim
- Mira Finish - All** 8931-RLS-HPA
Entire Fixture is in Mira High Polish Finish

FAUCET CONFIGURATION



- Single Hole** - H1

Neo-Metro Deck Mounted Faucet is available for this Metropolis Basin (Sold Separately)



- NMF-2-S (Satin Finish)
- NMF-2-HP (Mira High Polish)



- Less Punching** - H0
(Requires Wall Mounted Faucet)



- BOWL OVERFLOW OPTION**
- Overflow Outlet** - OF



APPROVAL FOR MANUFACTURE

COMPANY: _____

PROJECT NAME: _____

SIGNEE'S NAME WRITTEN CLEARLY: _____

DATE _____

AUTHORIZED SIGNATURE: _____

Metropolis Basin

PRODUCT Specification . . . Neo-Metro's patented (U.S. Design Patent 433743) conical shaped pedestal basin shall be manufactured entirely of 16-gage, type 304 stainless steel, with seam welded construction. Basin shall have a 1-1/2" (38mm) diameter drain opening for standard drain fitting. Basin shall be available with a 'D' shaped bowl (8930), a large 15-3/4" (400mm) round bowl (8931-RLL) or a small 11-1/2" (290mm) round bowl (8931-RLS). The fixture is available completely in a Satin Finish (-S), Satin Finish with a Mira (high polish) rim (-HPR), or completely in Mira Finish (-HPA). Customer

must also specify faucet mounting preference. A single hole faucet is available separately through Neo-Metro.

PLUMBING Specification . . . Basin shall be wall mounted and supported on floor. Concealed rear panel provides access to drain and P-trap (p-trap by others). 'D' Basin (8930) and 11-1/2" Round Basin (8931-RLS) can be factory punched with single hole or 6" (152 mm) center set (customer must specify at time of ordering). Holes punched for faucets are 1-5/16" (33 mm) diameter. The basin can be manufactured with an overflow outlet.

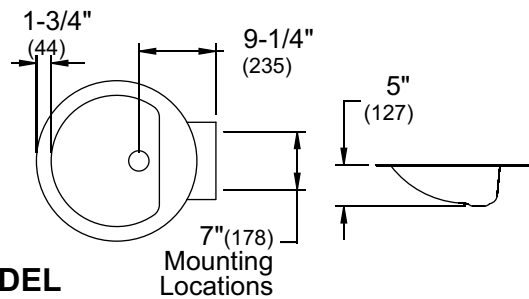
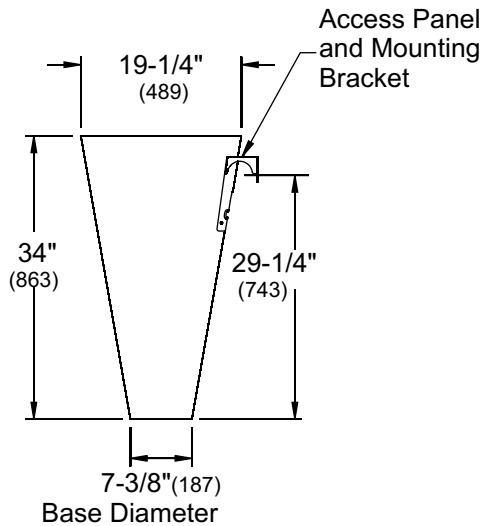

MODEL 8930-H0

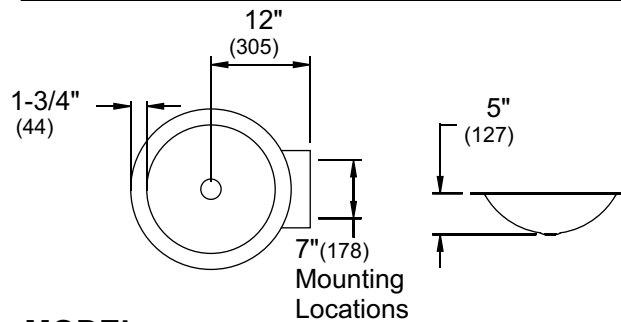

MODEL 8931-RLL-H0

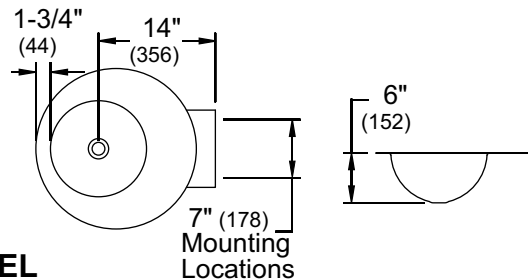

MODEL 8931-RLS-H0

Neo-Metro assumes no responsibility for use of void or suspended data. All dimensions are nominal and subject to manufacturer change without notice.

INSTALLATION INSTRUCTIONS ARE AVAILABLE