

18-1/2" SQ.

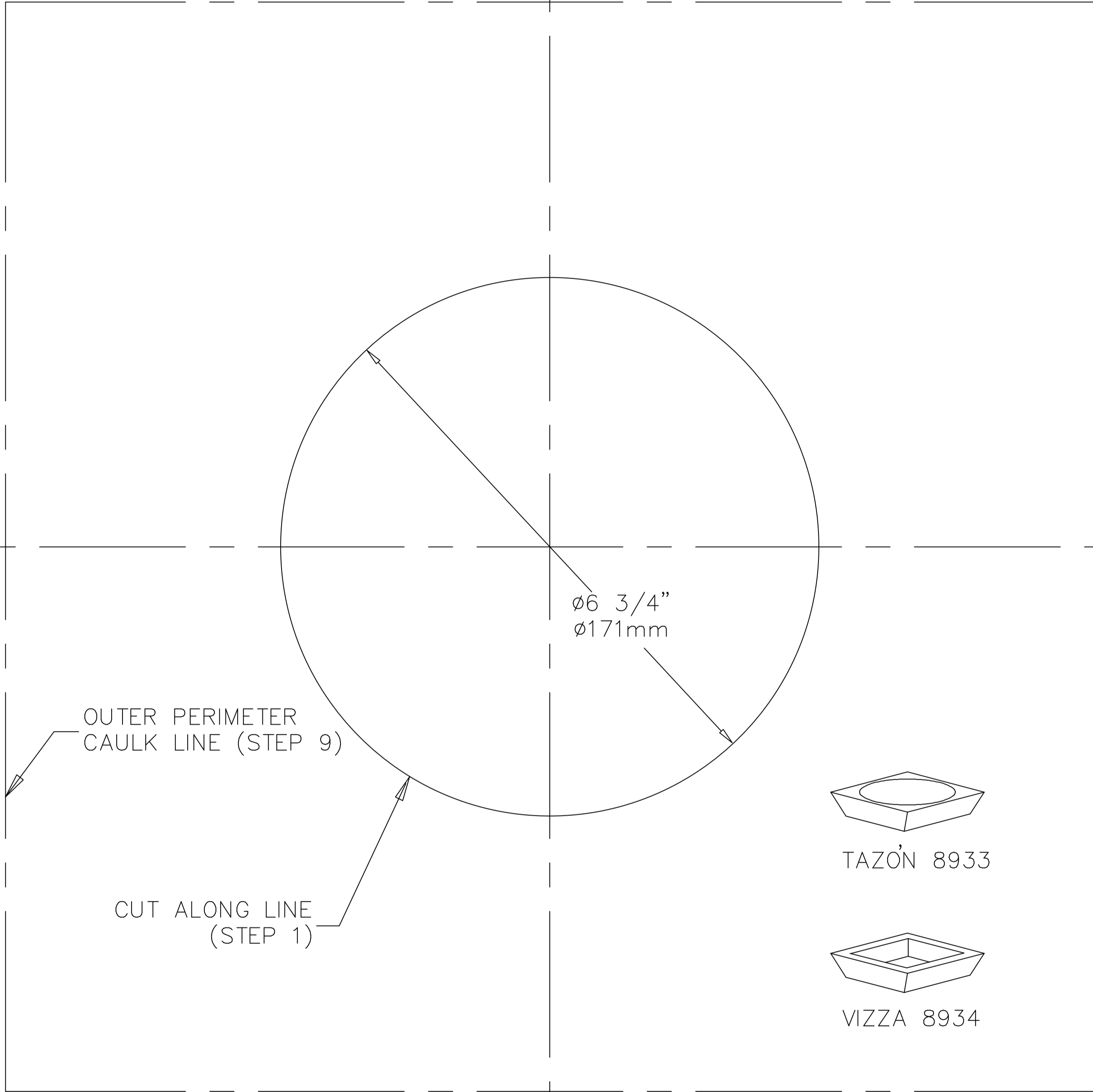

CUT-OUT TEMPLATE AND INSTALLATION
INSTRUCTIONS FOR TAZÓN AND VIZZA VESSEL



OUTER PERIMETER
CAULK LINE (STEP 9)

CUT ALONG LINE
(STEP 1)

Ø6 3/4"
Ø171mm

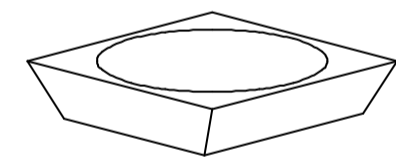

TAZÓN 8933

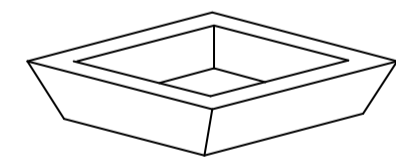

VIZZA 8934

RIM OF VESSEL



FAX: (626) 937-4725
EMAIL: INFO@NEO-METRO.COM
WEB: WWW.NEO-METRO.COM

RECOMMENDED TOOLS AND MATERIALS



CAULK

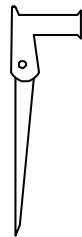

KEYHOLE OR
SABER SAW

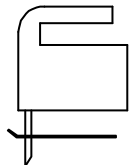

PENCIL

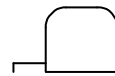

TAPE
MEASURE

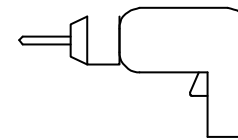

DRILL

BEFORE YOU BEGIN

NOTE: IF A WALL-MOUNTED FAUCET IS USED, ALLOW SUFFICIENT SPOUT OVERHANG INTO THE VESSEL. THE SPOUT MUST BE 7-1/2" (19cm) LONG MINIMUM FOR ADEQUATE CLEARANCE INTO THE VESSEL.

- PRIOR TO INSTALLATION, UNPACK AND INSPECT VESSEL FOR DAMAGE.
- RETURN VESSEL TO ITS PROTECTIVE CARTON UNTIL YOU ARE READY TO INSTALL IT.
- THE FOLLOWING ARE DIMENSIONS FOR COMPARISON ONLY:

VESSEL AREA 14-1/2" x 14-1/2" (36.8cm x 36.8cm)

WATER DEPTH 4-1/2" (11.4cm)

OUTLET DIAMETER 1-5/8" (4.1cm)

INSTALL THE VESSEL

1. CUT OUT THE 6-3/4" DIAMETER CENTER OF THE TEMPLATE.
2. POSITION THE TEMPLATE ON THE COUNTERTOP.
3. REFER TO FAUCET INSTALLATION INSTRUCTIONS AND MARK THE DESIRED FAUCET HOLE LOCATIONS.
4. USE A PENCIL TO TRACE THE TEMPLATE ON THE COUNTERTOP.
5. CUT OUT THE CENTER OPENING BY CAREFULLY FOLLOWING THE PENCIL LINE TRACED FROM THE TEMPLATE.
6. SET THE VESSEL INTO THE COUNTERTOP CUT-OUT AND CHECK THE FIT.
7. REMOVE THE VESSEL FROM THE COUNTERTOP.
8. INSTALL THE WALL-MOUNTED FAUCET ACCORDING TO MANUFACTURE'S INSTRUCTIONS.
9. CUT TEMPLATE AROUND OUTER PERIMETER CAULK LINE. CENTER TEMPLATE ON COUNTERTOP CUT-OUT AND MARK OUTER PERIMETER CAULK LINE WITH A PENCIL.
10. APPLY A CONTINUOUS BEAD OF CAULK AROUND THE COUNTERTOP CUT-OUT HOLE AND OUTER PERIMETER CAULK LINE.
11. CAREFULLY SET THE VESSEL INTO PLACE OVER THE CUT OUT HOLE.
12. POSITION THE MOUNTING RING HOLES OVER THE VESSEL STUDS.
13. SECURELY HAND TIGHTEN WING NUTS TO EVENLY DRAW DOWN THE VESSEL TO THE COUNTERTOP. DO NOT OVERTIGHTEN.
14. CAREFULLY WIPE AWAY ANY EXCESS CAULK.

VIZZA 8934 SHOWN

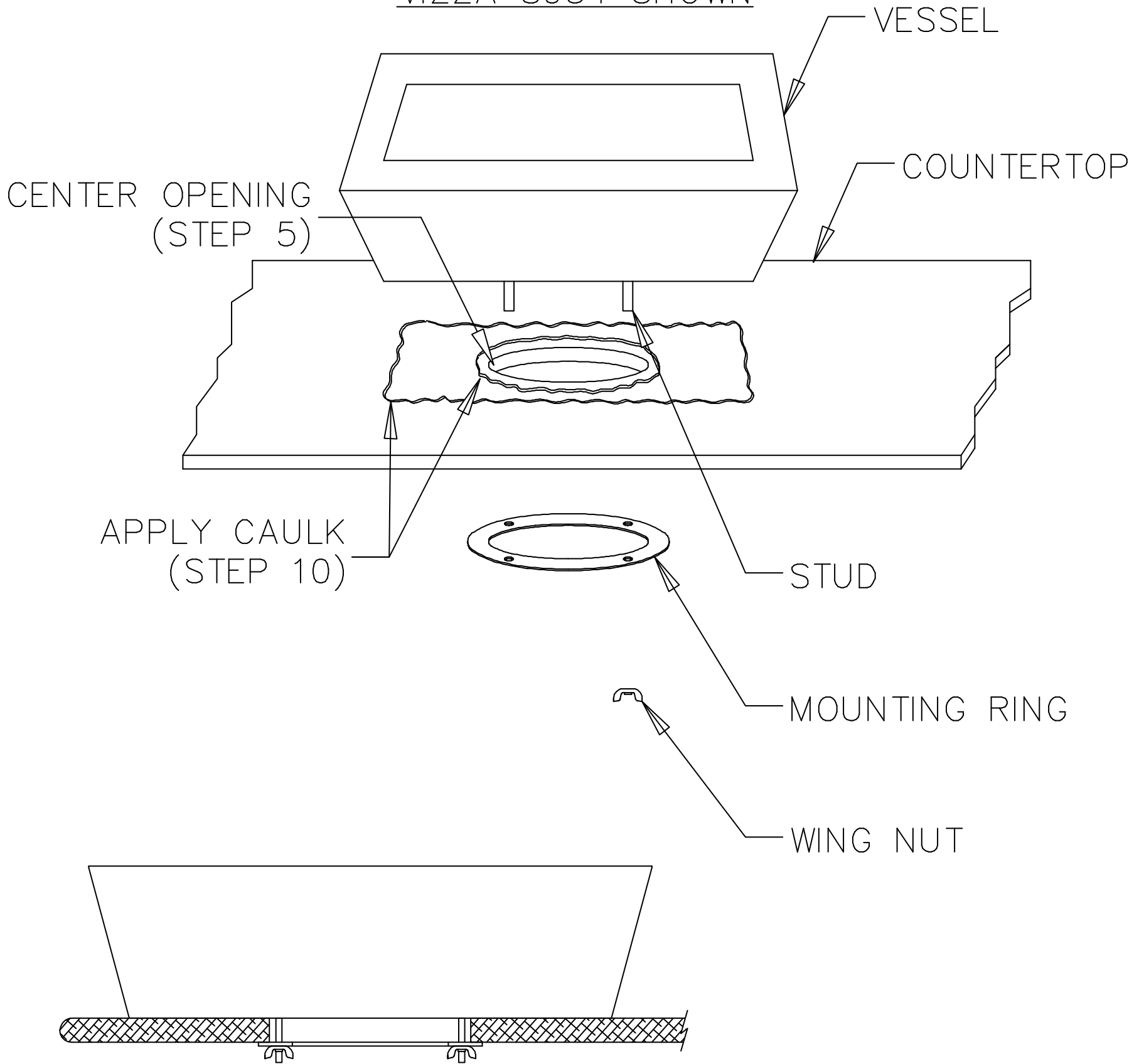

ABOVE THE COUNTER
INSTALLATION

L1000993